

Bending

Standard single-pass tubular elements may be bent in an infinite variety of configurations. Utilizing the most up-to-date computer numerical control (CNC) bending equipment and techniques, Heatrex is able to produce an element to fit virtually any application.

Certain bends are normally repressed on unfinned elements to recompact the magnesium oxide insulation, eliminating hairline cracks that may develop during bending. As described in the following table.

Element Diameter	Normally Repress if C-C less than
0.200	1
0.250/0.260	1.375
0.315	1.5625
0.375	1.75
0.430	1.875
0.475/0.490	2
0.625	2.5

The Figures 5 through 39 on the following pages show some of the configurations frequently specified. For configurations not shown, submit a drawing or sketch of your requirements. Any of these are available either finned or unfinned.

Table VI

Element Diameter	Sheath Materials	Minimum Bend Radius for 180° Bends	Minimum Bend Radius for 90° Bends
0.200	Incoloy 840	0.225	0.1625
0.250	304 SST	0.25	0.1875
	321 SST	0.25	
	Incoloy 840	0.25	
	Incoloy 800	0.3125	
	Monel	0.25	
	CUPLDSTL	0.25	
	Copper	0.25	
0.260	304 SST	0.255	0.1925
	321 SST	0.255	
	Incoloy 840	0.255	
	Incoloy 800	0.3175	
	Monel	0.255	
	CUPLDSTL	0.255	
0.315	304 SST	0.4075	0.2825
	316 SST	0.37125	
	321 SST	0.37125	
	Incoloy 840	0.37125	
	Incoloy 800	0.4075	
	Monel	0.4075	
	CUPLDSTL	0.4075	
	Steel	0.4075	
Copper	0.4075		
0.375	304 SST	0.37125	0.3125
	321 SST	0.37125	
	Incoloy 840	0.4375	
	Incoloy 800	0.4375	

Element Diameter	Sheath Materials	Minimum Bend Radius for 180° Bends	Minimum Bend Radius for 90° Bends
0.430	304 SST	0.37125	0.37125
	316 SST	0.37125	
	321 SST	0.37125	
	Incoloy 840	0.5	
	Incoloy 800	0.5	
	Monel	0.5	
	Inconel 600	0.59	
	CUPLDSTL	0.4375	
	Steel	0.4375	
	Copper	0.4375	
0.475	304 SST	0.5	0.39375
	316 SST	0.5	
	321 SST	0.5	
	Incoloy 840	0.5	
	Incoloy 800	0.5	
	Monel	0.5	
	Inconel 600	0.7375	
	Steel	0.5	
0.490	304 SST	0.5	0.40125
	316 SST	0.5	
	321 SST	0.5	
	Incoloy 840	0.5	
	Incoloy 800	0.5	
	Monel	0.62	
	Inconel 600	0.745	
	Steel	0.62	
0.625	321 SST	0.8125	0.5625
	Incoloy 840	0.8125	
	Inconel 600	0.9375	

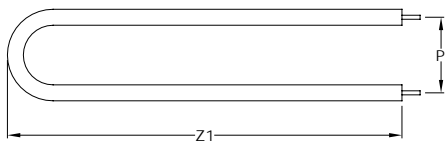

FIGURE 5

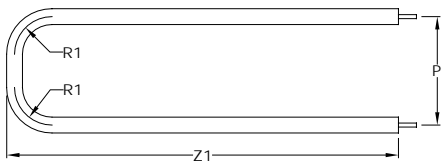

FIGURE 6

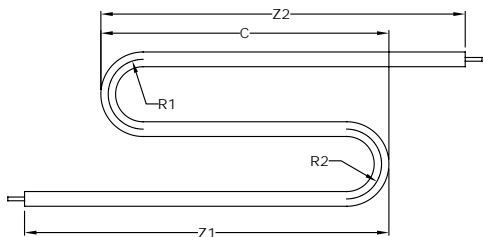

FIGURE 8

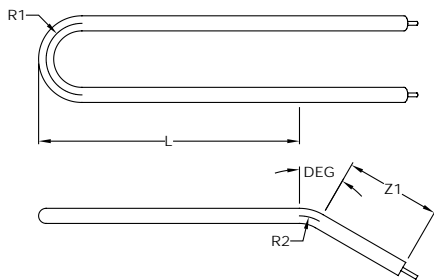

FIGURE 9

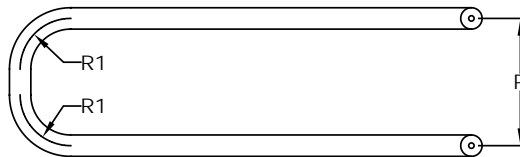

FIGURE 10

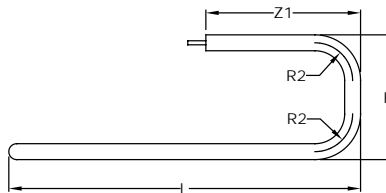
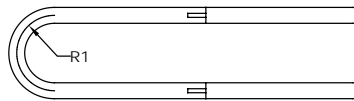

FIGURE 11

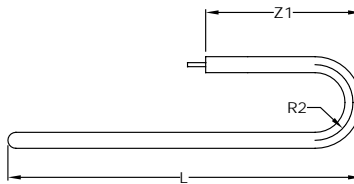

FIGURE 12

Bending

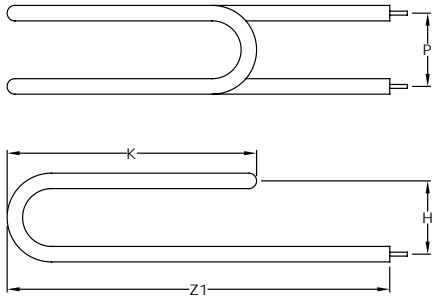

FIGURE 13

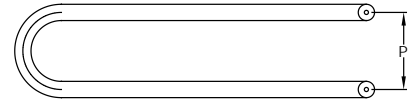

FIGURE 16

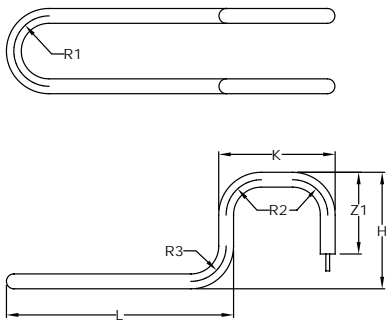

FIGURE 14

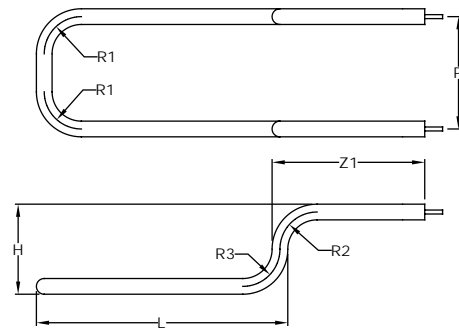

FIGURE 17

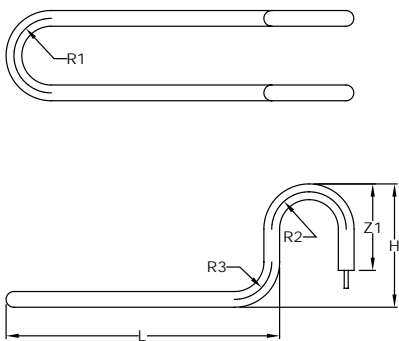

FIGURE 15

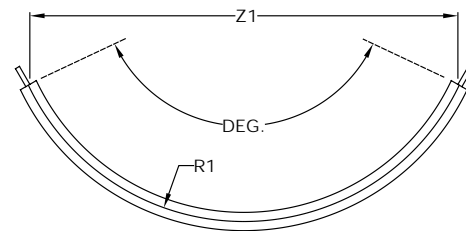

FIGURE 18

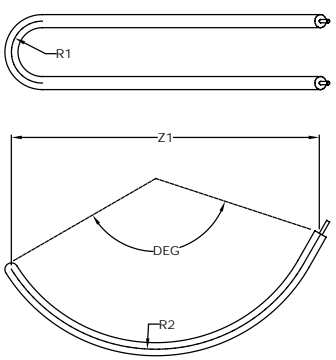

FIGURE 19

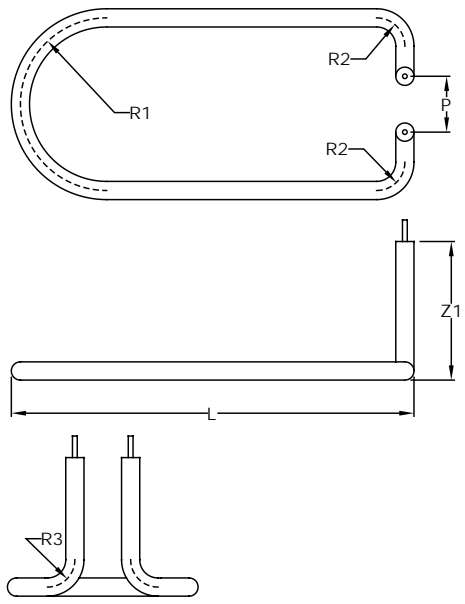

FIGURE 20

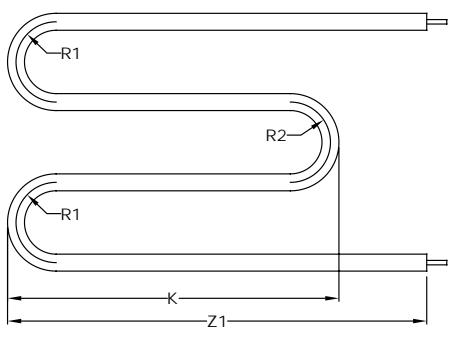

FIGURE 21

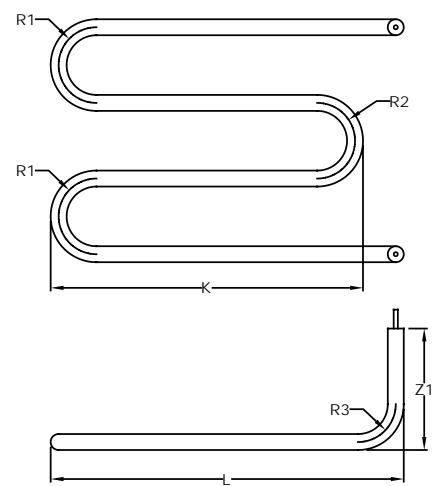

FIGURE 22

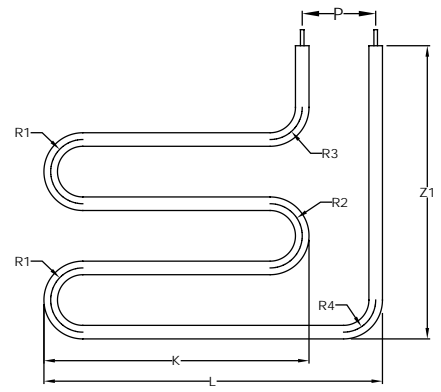

FIGURE 23

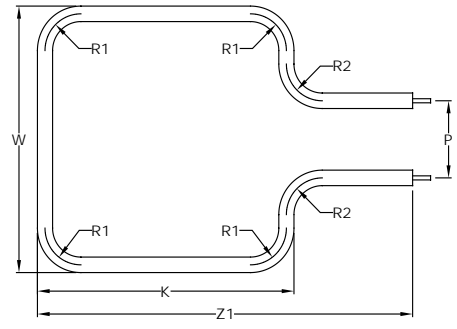

FIGURE 24

Bending

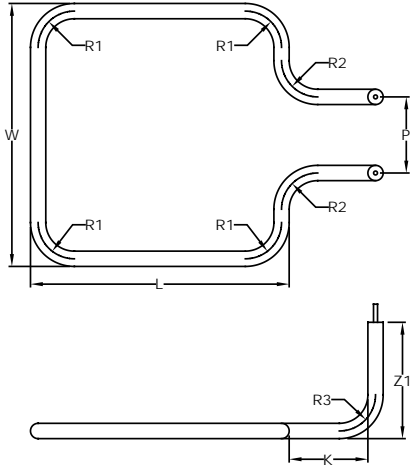

FIGURE 25

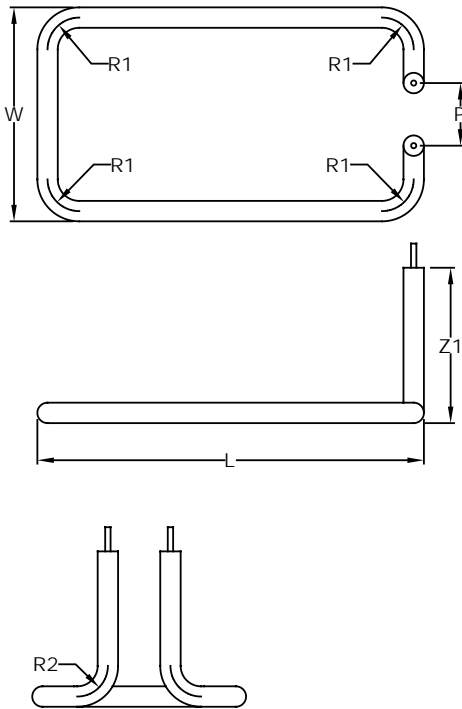

FIGURE 26

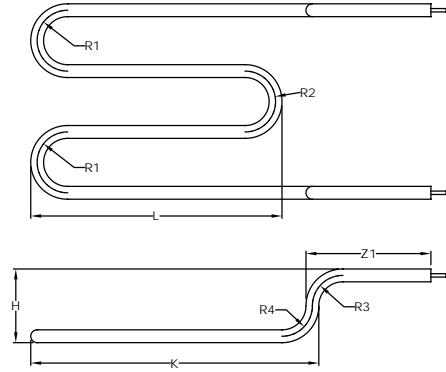

FIGURE 27

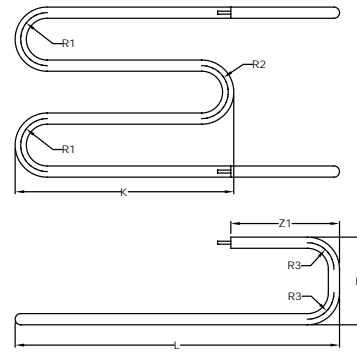

FIGURE 28

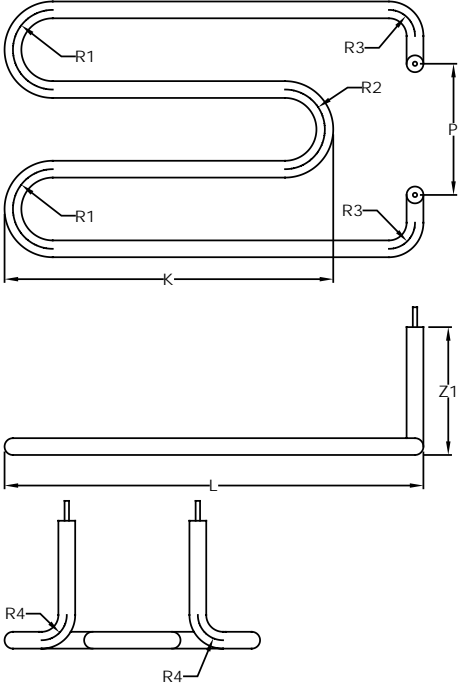

FIGURE 29

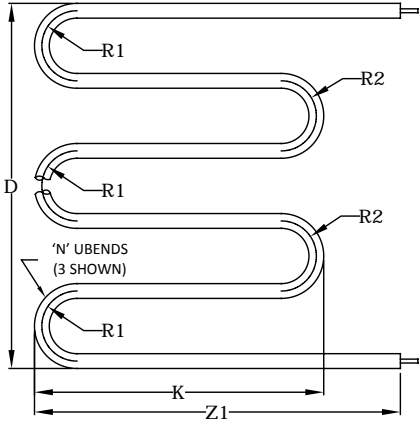

FIGURE 30

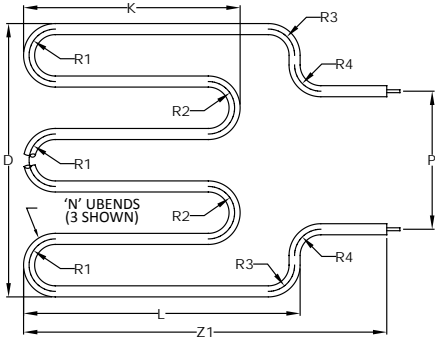

FIGURE 31

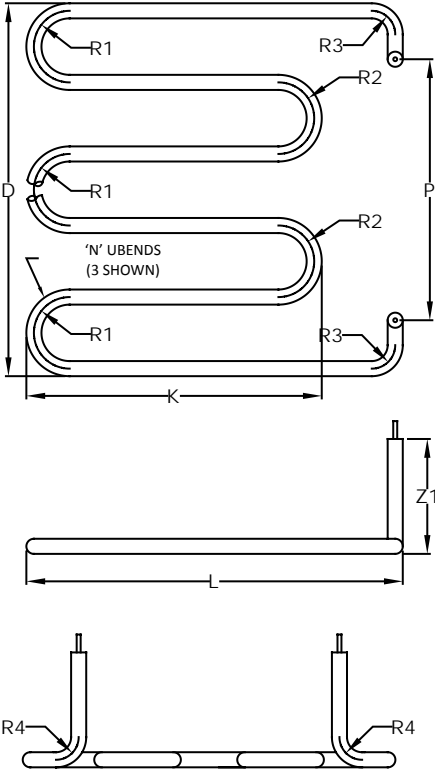

FIGURE 32

Bending

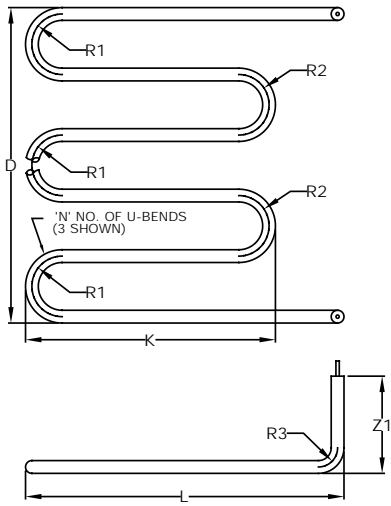

FIGURE 33

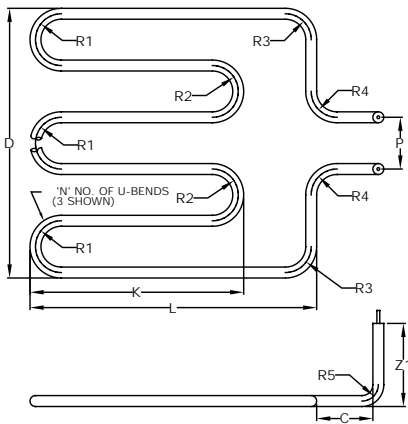

FIGURE 34

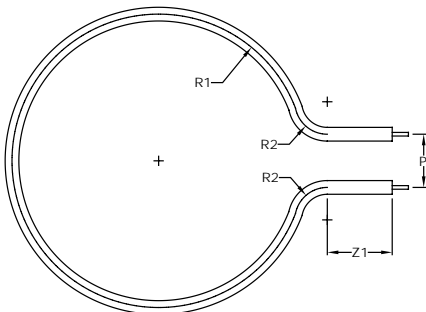

FIGURE 35

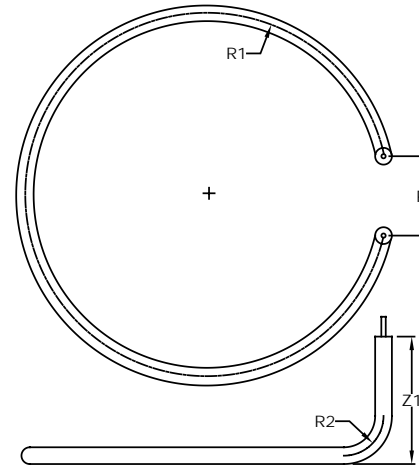

FIGURE 36

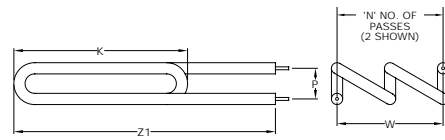

FIGURE 37

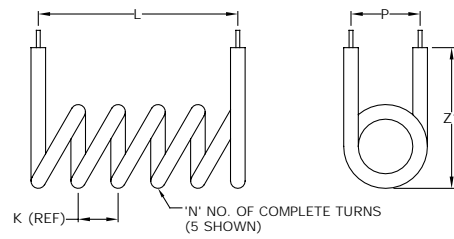

FIGURE 38

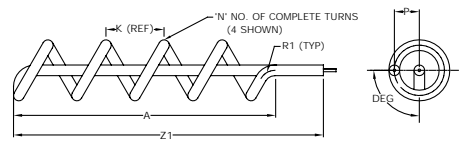

FIGURE 39